

ZL-2002 *Zwei L* Stainless Steel Handle

Features

- Superior "Zwei L Finish" - *Zwei L* represents the very pinnacle of ultra-premium Japanese hardware design. The contrasting bands of mirror finish and lustrous satin on a faceted profile give a jewel like finish that highlights and enhances any industrial design

Notes

- When installing to thin sheet metal or acrylic sheet, mounting surface may not be horizontal and the sheet may warp. Please check with actual item.

Parts Included

- Truss head screw M5x30 (SUS)

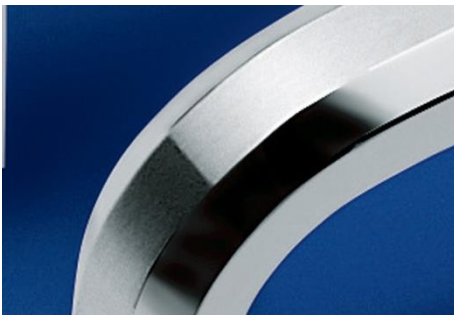

Superior finishing

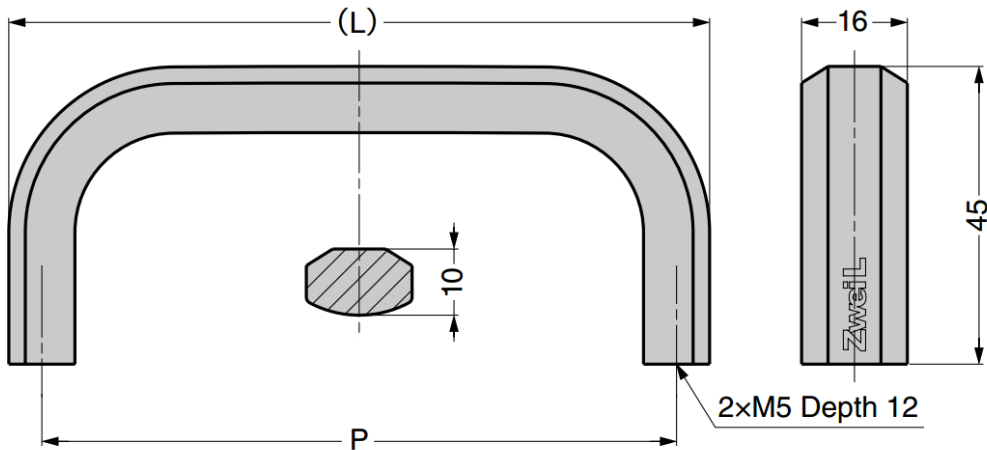

Part No.	Material	Finish	L	P
ZL-2002-96	Stainless Steel 316	Zwei L Finish	106	96
ZL-2002-128			138	128
ZL-2002-160			170	160
ZL-2002-192			202	192
ZL-2002-256			266	256
ZL-2002-320			330	320
ZL-2002-416			426	416
ZL-2002-512			522	512

ZL-2301 *Zwei L* Stainless Steel Handle Bracket

Features

- Bracket for installing handle ZL-2001 and ZL-2002 on glass doors
- For glass doors of 4, 5 and 6 mm thickness

① ZL glass mounting bracket $\phi 16$

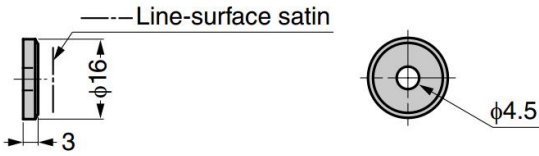

② ZL glass mounting bracket $\phi 25$

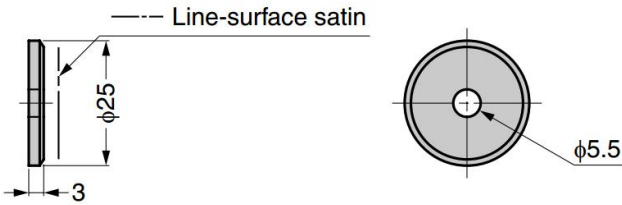

③ Gasket for ZL glass mounting bracket $\phi 14$

④ Gasket for ZL glass mounting bracket $\phi 20$

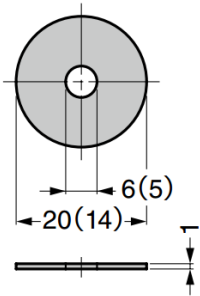
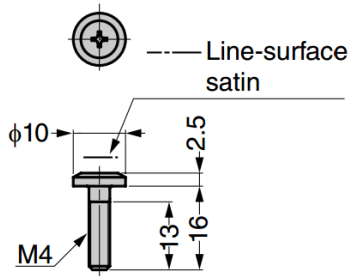

Figure above shows ④.
Dimensions in () are for ③.

⑤ ZL countersunk head screw M4x16



Glass processing hole
 $\phi 5$ (glass thickness 4, 5)
 $\phi 6$ (glass thickness 6)

⑥ ZL countersunk head screw M5x16

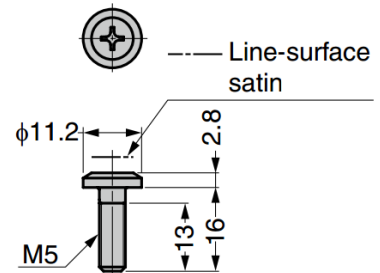

Glass processing hole $\phi 6$

Bracket set for ZL-2001 $\phi 16$ (with screw)

No.	Part Name	Material	Finish / Colour
①	Bracket ($\phi 16$)	Stainless Steel (SUS316)	Zwei L Finish
③	Gasket ($\phi 14$)	Elastomer (TPE)	Clear
⑤	Truss Head Screw M4 x 16	Stainless Steel	Zwei L Finish

Bracket set for ZL-2002 $\phi 25$ (with screw)

No.	Part Name	Material	Finish / Colour
②	Bracket ($\phi 25$)	Stainless Steel (SUS316)	Zwei L Finish
③	Gasket ($\phi 14$)	Elastomer (TPE)	Clear
④	Gasket ($\phi 20$)		
⑥	Truss Head Screw M5 x 16	Stainless Steel	Zwei L Finish

Part No.

ZL-2301-2016

Part No.

ZL-2301-2025